

SCALE 1:1

2834-TEMPLATE

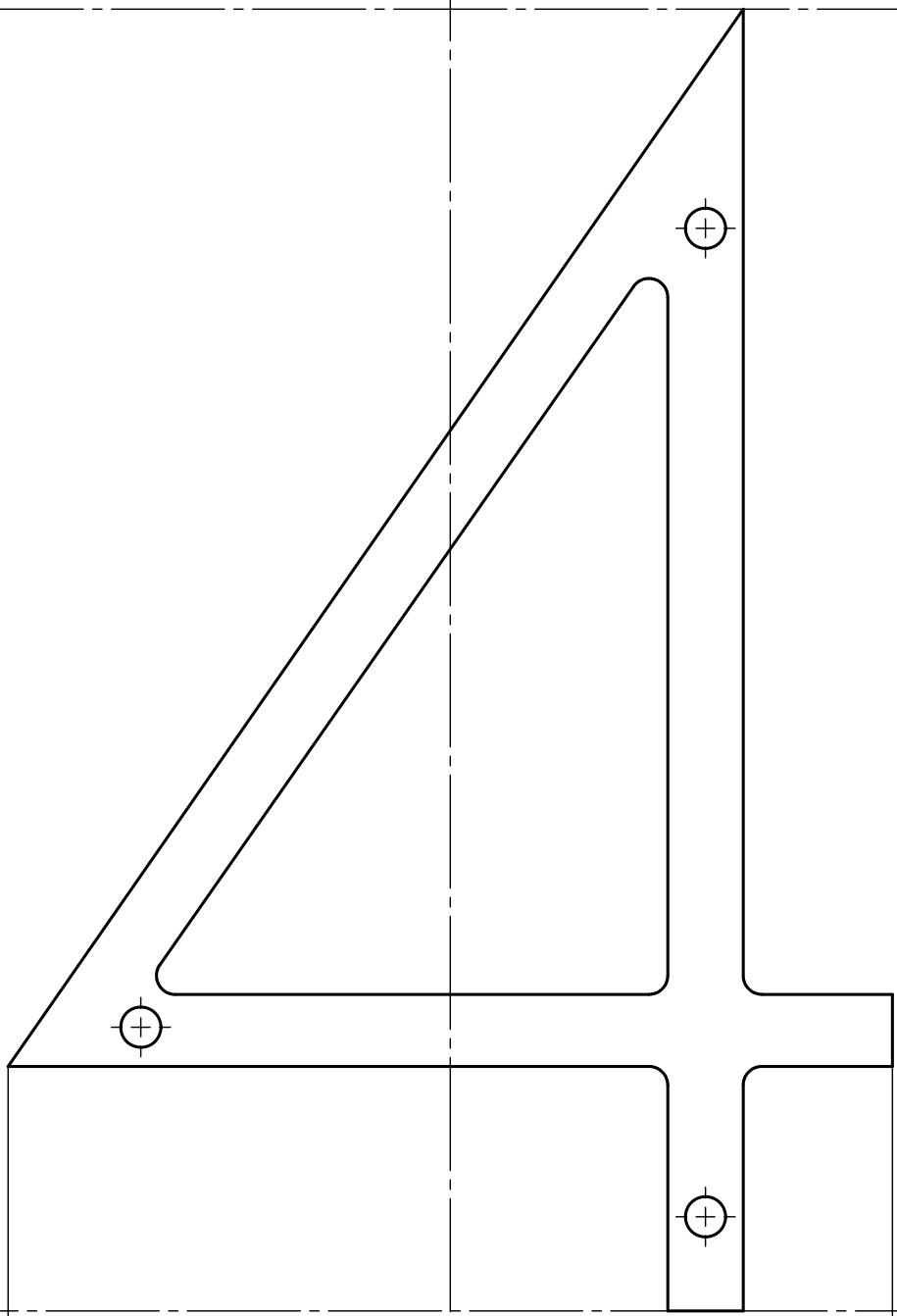
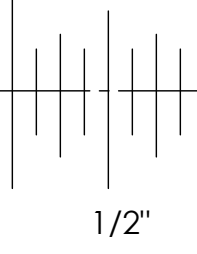
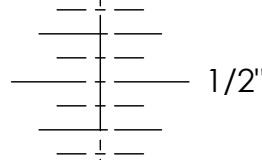
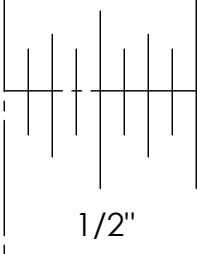
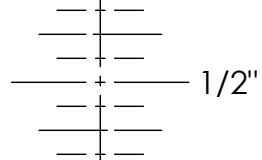

## Modern House Number Installation Instructions

### Surface

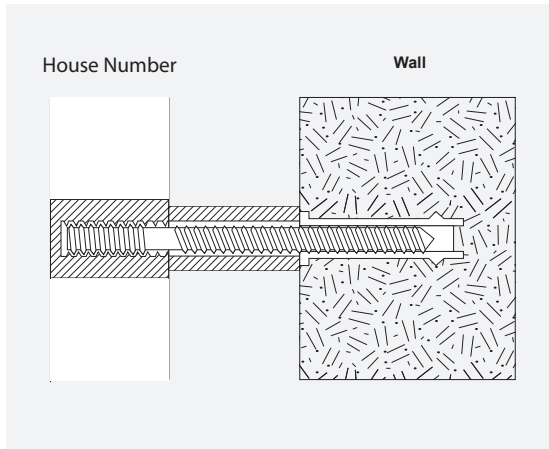

Use 1/4" drill bit for wall anchors.

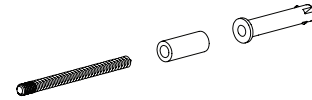
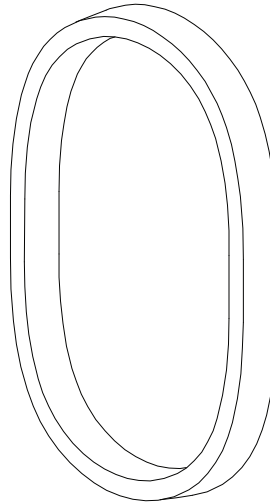

#### Floating Mount

- Install with threaded rods, standoffs and anchors

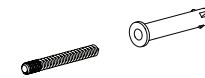

#### Flush Mount

- Install with threaded rods and anchors

### Thru-Bolt

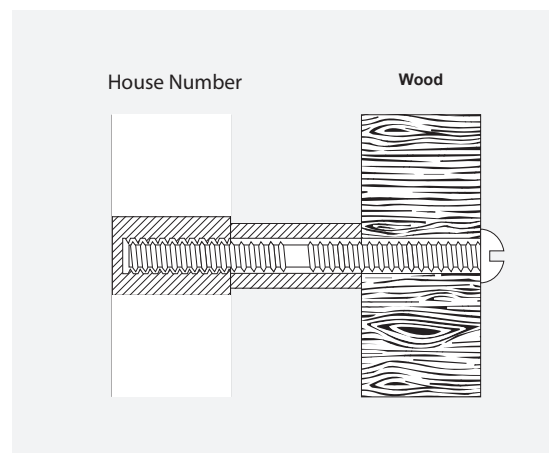

#8-32 Breakaway screws provide for easy shortening.

Use 3/16" drill bit for breakaway screws.

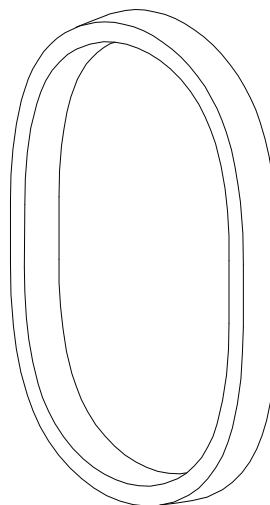

#### Floating Mount

- Install with standoffs and breakaway screws



#### Flush Mount

- Install with breakaway screws