

SCALE 1:1

2830-TEMPLATE

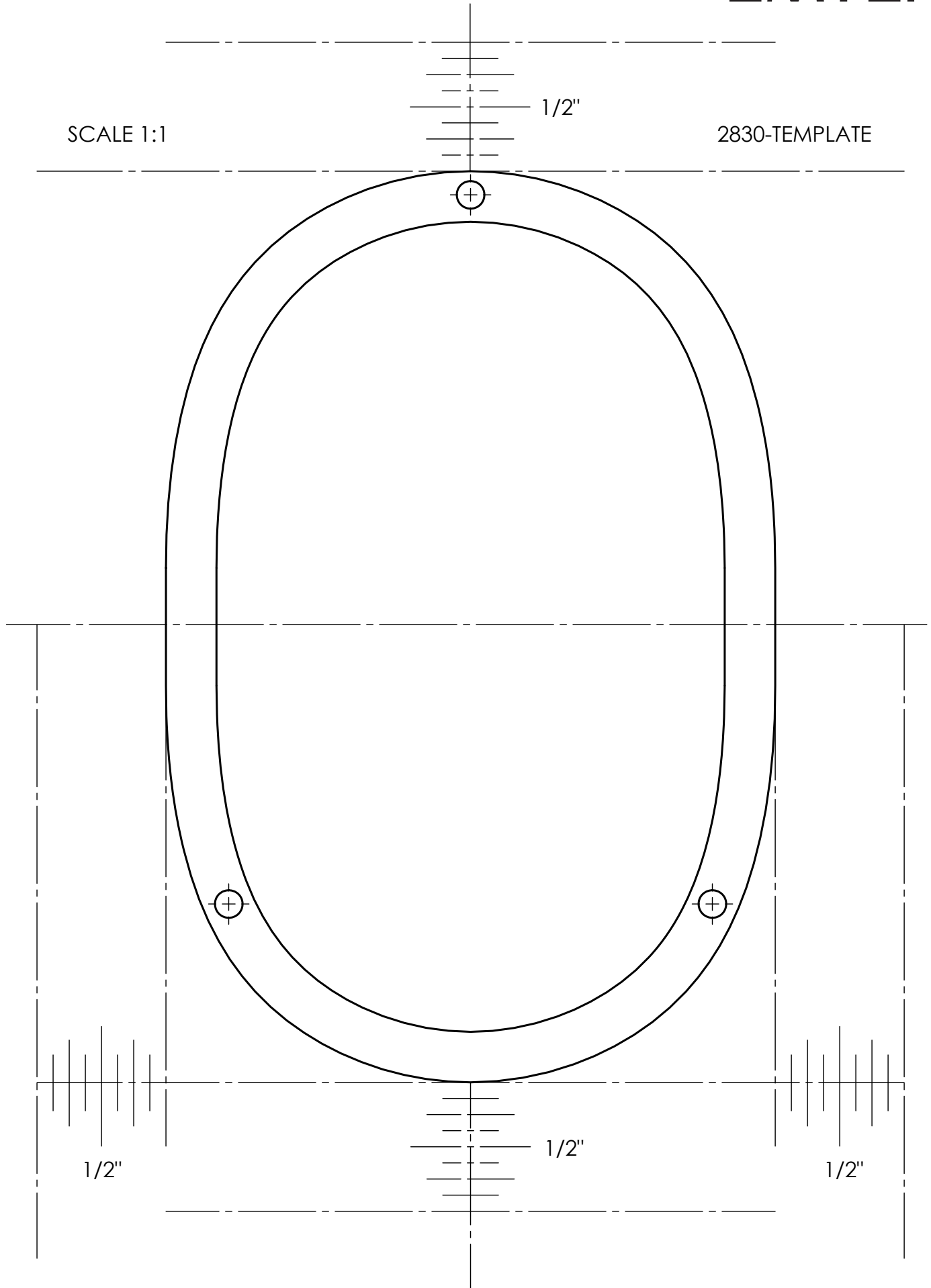

Modern House Number Installation Instructions

Surface

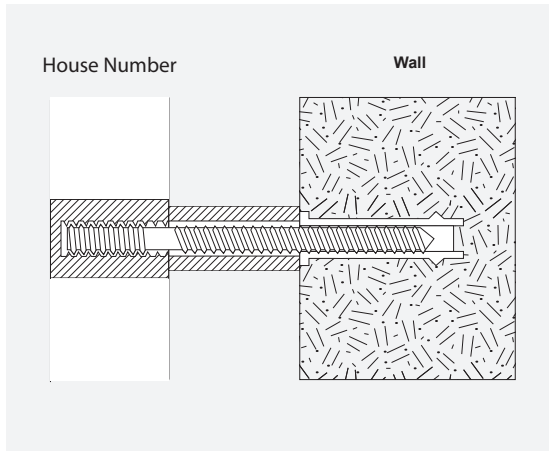

Use 1/4" drill bit for wall anchors.

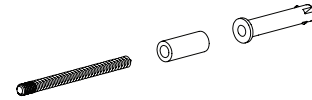
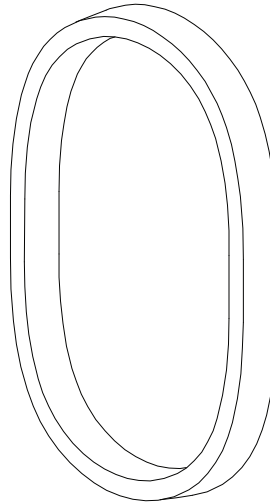

Floating Mount

- Install with threaded rods, standoffs and anchors

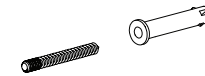

Flush Mount

- Install with threaded rods and anchors

Thru-Bolt

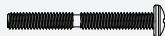
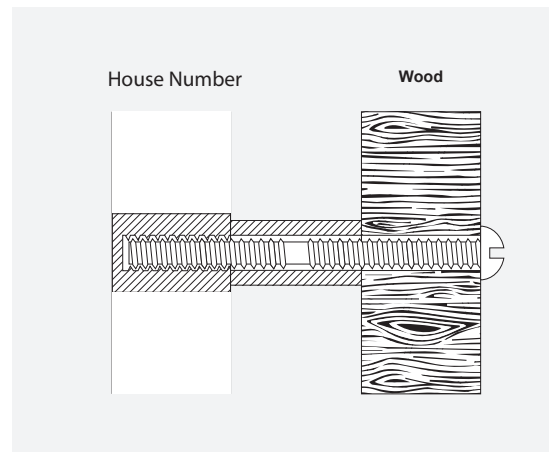

#8-32 Breakaway screws provide for easy shortening.

Use 3/16" drill bit for breakaway screws.

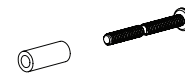
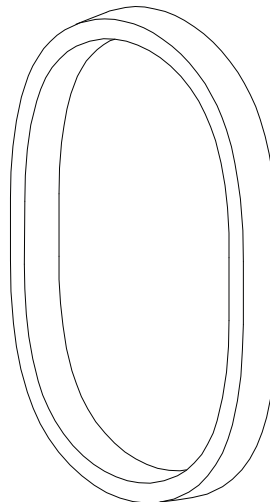

Floating Mount

- Install with standoffs and breakaway screws



Flush Mount

- Install with breakaway screws